



**TURBO INDIA**

INTERCONNECT SOLUTIONS LLP

**QUALITY  
YOU CAN  
TRUST**



## **TBS310 SERIES CONNECTORS**

(SAE-AS50151/MIL-DTL-5015/  
JSS 50812)



  
**AS9100  
REV. D**



**solotek**  
elektronik



---

# CONTENTS

1.	ABOUT TURBO INDIA INTERCONNECT SOLUTIONS.....	1
2.	CAPABILITIES & SERVING AREAS.....	2
3.	ABOUT CONNECTOR.....	3
4.	TECHNICAL SPECIFICATION.....	4
5.	MATING COMBINATIONS.....	6
7.	PART NUMBER COMPARISION.....	7
8.	ORDERING INFORMATION.....	8
8.	INSERT ARRANGEMENTS.....	9
9.	INSERT ORIENTATIONS.....	26
10.	RECEPTACLE CONNECTOR.....	32
11.	PLUG CONNECTOR.....	36
12.	PROTECTIVE COVERS.....	38
13.	FACILITIES.....	40
14.	SUMMARY.....	41



## WHO WE ARE

Turbo India Interconnect Solutions (TICS) – subsidiary of Turbo India, is an AS9100 certified company, specialized in manufacture and supply of Connectors, Backshells, Protective Covers, Electrical Contacts and Components for Military, Aerospace and Industrial applications, against standard and custom requirements.

Headquartered in Bangalore, India, the 4000sq.m. facility is equipped with adequate infrastructure for the design, manufacture, assembly, testing and inspection of interconnect products.

The long-standing manufacturing expertise of the Turbo group, spanning over two decades since 1996, supporting the Military and Aerospace industry, equips TICS to work in collaboration with its customers to offer a complete solution.



## VISION

To be a trusted and reliable hub for on-time, best in-class quality solutions for the interconnect requirements of Military, Aerospace, Industrial, Railways, Marine, Oil & Gas, and Medical sectors.



## MISSION

The TICS family will continuously strive towards delighting the customers with on-time quality solutions, by utilizing world class facilities, following industry best practices, adopting a never-ending exercise of continuous improvement and employee engagement.





# CAPABILITIES

**SALES** – With sales and distribution networks in India, Europe & the USA, we are ever closer to our customers. Our sales team, capable of understanding your needs and expectations, is focused on delivering the right solution and the best customer experience.

**ENGINEERING** – Our dedicated engineering team, equipped and aided with adequate product knowledge and software technologies, are capable of providing standard or bespoke interconnect solutions by working in partnership with you for specific designs to best suit your needs.

**PRODUCTION** – Our fleet of high-end CNC machines, aided by decades of experience, are capable of manufacturing complex geometries. With machining, surface plating and assembly facilities under one roof, we assure highest quality in quick turn-around time.

**COST AND LEAD TIME** – Through constantly reviewing our manufacturing process and implementing continual improvement practices, we always aim to pass on the benefits of cost and lead time to our customers.

## SERVING AREAS.....

AEROSPACE



LAND SYSTEM



SPACE



MARINE



MILITARY



COMMERCIAL



## ABOUT CONNECTOR :

The TBS310 series connectors are thread coupled environment resisting, circular electrical connectors designed to suite either receptacle or plug requirements, based on SAE -AS50151/MIL-DTL-5015/JSS 50812 standard.

The connectors come in 10 different shell sizes from 10 to 36 with different insert arrangements in each , based on MIL-STD-1651 and are offered with captivated solder cup contacts and outer shells with conductive olive drab cadmium/ electroless nickel/ black zinc-nickel finish, for corrosion resistance. The materials employed ensures that the connector assembly will retain its operating characteristics to an operating temperature range of -55°C to 125°C.

The receptacle connectors have different mounting options – wall mount/ box mount/ jamnut mount or in-line (cable connecting).

The plug connectors are offered with strain relief and EMI/RFI backshells.

These connectors are recommended for a wide range of applications, from commercial/industrial and mass transportation systems to the most stringent high reliability defense and aerospace requirements.



## TECHNICAL SPECIFICATION

MATERIAL AND FINISHES	
Shell	Aluminum Alloy
Plating	Olive Drab Cadmium
Contacts	Copper Alloy (Silver Plated)
Insert	Elastomer
Grommets and Seals	Elastomer

MECHANICAL	
Durability	500 cycles
Vibration Resistance	10g at 10-500Hz
Shock Resistance	50g, 11ms duration

ELECTRICAL	
Insulation Resistance	$\geq 5000M\Omega$ at 500 VDC
Current Rating	Up to 150 A (Depends on contact size)
Dielectric Withstanding Voltage	1000 Vrms Instrument
	2000 Vrms service A

## TECHNICAL SPECIFICATION

ENVIRONMENTAL/CLIMATE	
Operating Temperature	-55°C TO 125°C
Salt Spray	48 Hours
Fluid Resistance	Hydraulic fluids -MIL-PRF-5606 (20Hours)
	Lubricating oils-MIL-PRF-7808(20Hours)

CONTACT RATING		
CONTACT SIZE	RATED CURRENT (A)	CONTACT RESISTANCE (mΩ)
16	13	3.46
12	23	1.83
8	46	0.52
4	80	0.26
0	150	0.14

DIELECTRIC WITHSTANDING TEST VOLTAGES						
SERVICE RATING	INST	A	D	E	B	C
TEST VOLTAGE AT SEA LEVEL AC (Vrms)	1000	2000	2800	3500	4500	7000
RATED WORKING VOLTAGE - DC AT SEA LEVEL (Vrms)	250	700	1250	1750	2450	4200
RATED WORKING VOLTAGE - AC AT SEA LEVEL (Vrms)	200	500	900	1250	1750	3000



## MATING COMBINATIONS

### STYLE 0 – WALL MOUNT RECEPTACLE

Designed for wall mounting, supplied with a removable cable clamp backshell providing strain relief.

**Mates with:**  
TBS 3106  
TBS 3108

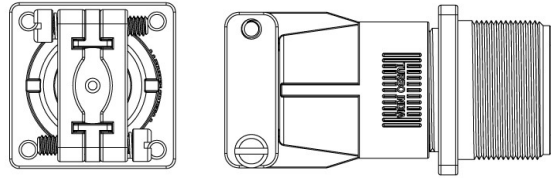

### STYLE 1 – IN-LINE RECEPTACLE

Designed for use where cable to cable connection is required. Supplied with a removable cable clamp backshell which provides & excellent strain relief.

**Mates with:**  
TBS 3106  
TBS 3108

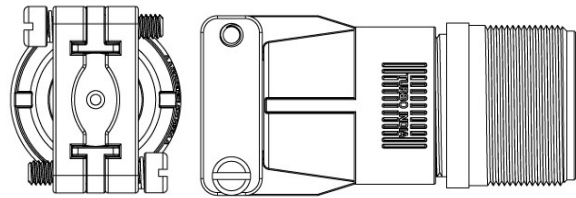

### STYLE 2 – BOX MOUNT RECEPTACLE

Designed for rear box mounting, supplied Without backshell.

**Mates with:**  
TBS 3106  
TBS 3108

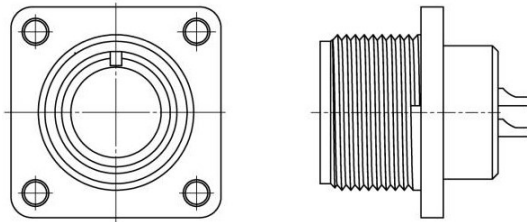

### STYLE 6 – PLUG WITH STRAIGHT BACKSHELL

Designed to be used on cable assemblies & is supplied with a 90° removable cable clamp Backshell provides excellent strain relief.

**Mates with:**  
TBS 3100  
TBS 3101  
TBS 3102

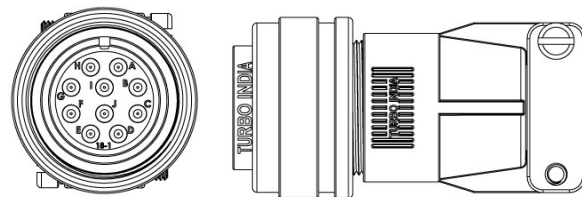

### STYLE 8 – PLUG WITH 90° BACKSHELL

Designed to be used on cable assemblies & is supplied with a 90° removable cable clamp Backshell provides excellent strain relief.

**Mates with:**  
TBS 3100  
TBS 3101  
TBS 3102

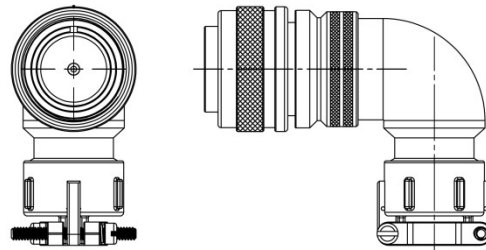



**POPULAR CROSS REFERENCE WITH TURBO PRODUCT SERIES**

Turbo Series Code	Military Standard Code	Amphenol Series Code	ITT Canon Series Code
TBS3100	MS3100	97-3100	CA3100
TBS3101	MS3101	97-3101	CA3101
TBS3102	MS3102	97-3102	CA3102
TBS3106	MS3106	97-3106	CA3106
TBS3108	MS3108	97-3108	CA3108



## ORDERING INFORMATION

TBS 3102 R W- 28 - 21 S W C -XX

## BRAND IDENTIFIER

## PRODUCT SERIES

3100 – Wall Mounting Receptacle  
 3101 – In-Line Receptacle  
 3102 – Box Mounting Receptacle  
 3106 – Plug with Straight backshell  
 3108 – Plug with 90° backshell

## PRODUCT CLASS

F – Applies to Plug 3106,3108 & Receptacle 3100 & 3101.  
 R – Environment Resistant – Applies to Receptacle 3102  
 (For Style 3100,3101,3106 & 3108 – Scope Short Endbell with Grommet)

## MATERIAL &amp; FINISH

W – Olive Drab Cadmium  
 N – Electroless Nickel  
 Z – Black Zinc Nickel  
 A – Black Anodized  
 VO – Zinc Cobalt

## SHELL SIZE

10SL,12S,14S,16S,18,20,22,24,28,32,36

## MODIFICATIONS

ZS – Crimp contact Silver plated  
 ZG – Crimp contact Gold plated  
 PC – PCB contact  
 GC – Gold plated contact

## BACKSHELL TYPE

C – Cable Clamp & Grommet  
 B – Banding Adapter & Grommet  
 E – Endbell & Grommet  
 A – Threaded Adapter  
 OMIT – No backshell

## ORIENTATION

W,X,Y,Z – Alternating Position Depending on Insert.  
 OMIT – For Normal Orientation

## CONTACT TYPE

P – Solder Contact – Male  
 S – Solder contact - Female

## CONTACT ARRANGEMENT

Refer page – 9 to 25

## INSERT ARRANGEMENTS

Contact Legend :- 16 12 8 4 0  
(AWG)

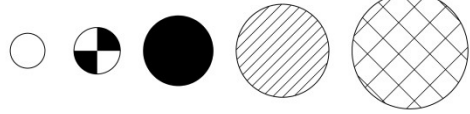

When Viewed from Face of Male Insulator

10SL



INSERT ARRANGEMENT	10SL-3	10SL-4
SERVICE RATING	INST	A
CONTACT POSITION	ALL	ALL
NO OF CONTACTS	3	2
CONTACT SIZE	16	16

12S



INSERT ARRANGEMENT	12S-3	12S-4
SERVICE RATING	A	D
CONTACT POSITION	ALL	ALL
NO OF CONTACTS	2	1
CONTACT SIZE	16	16

14S

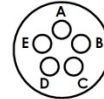
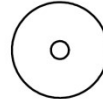
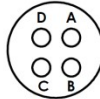
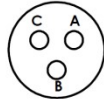

INSERT ARRANGEMENT	14S-1	14S-2	14S-4	14S-5
SERVICE RATING	A	INST	D	INST
CONTACT POSITION	ALL	ALL	ALL	ALL
NO OF CONTACTS	3	4	1	5
CONTACT SIZE	16	16	16	16

14S

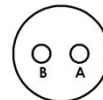
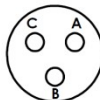
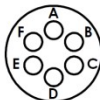

INSERT ARRANGEMENT	14S-6	14S-7	14S-9
SERVICE RATING	INST	A	A
CONTACT POSITION	ALL	ALL	ALL
NO OF CONTACTS	6	3	2
CONTACT SIZE	16	16	16

# INSERT ARRANGEMENTS

Contact Legend :- 16 12 8 4 0 (AWG)

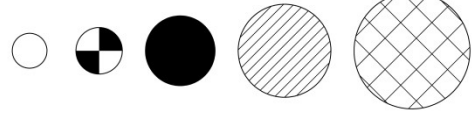

When Viewed from Face of Male Insulator

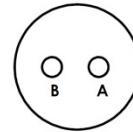
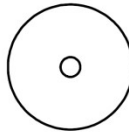
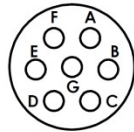

16S

INSERT ARRANGEMENT	16S-1	16S-3	16S-4
SERVICE RATING	A	B	D
CONTACT POSITION	ALL	ALL	ALL
NO OF CONTACTS	7	1	2
CONTACT SIZE	16	16	16

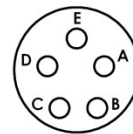
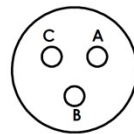
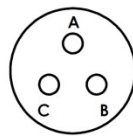

16S

INSERT ARRANGEMENT	16S-5	16S-6	16S-8
SERVICE RATING	A	A	A
CONTACT POSITION	ALL	ALL	ALL
NO OF CONTACTS	3	3	5
CONTACT SIZE	16	16	16

# INSERT ARRANGEMENTS

Contact Legend :- 16 12 8 4 0 (AWG)

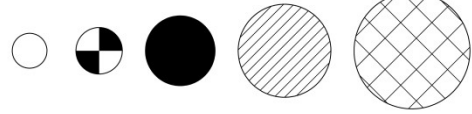

When Viewed from Face of Male Insulator

18

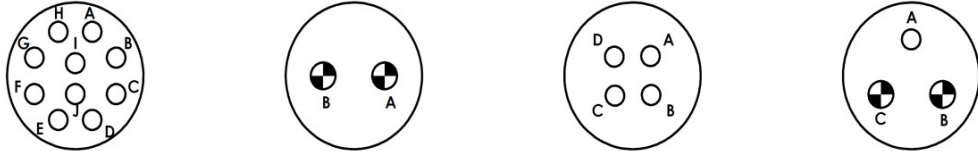

INSERT ARRANGEMENT	18-1		18-3	18-4	18-5	
SERVICE RATING	A	INST	D	D	D	
CONTACT POSITION	B, C, F, G	ALL OTHERS	ALL	ALL	ALL	
NO OF CONTACTS	4	6	2	4	1	2
CONTACT SIZE	16		12	16	16	12

18

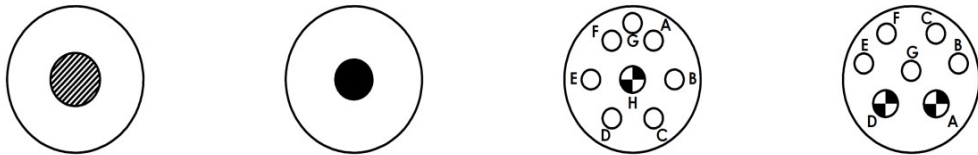

INSERT ARRANGEMENT	18-6	18-7	18-8		18-9	
SERVICE RATING	D	B	A		INST	
CONTACT POSITION	ALL	ALL	ALL		B, C, E, F, G	A, D
NO OF CONTACTS	1	1	7	1	5	2
CONTACT SIZE	4	8	16	12	16	12

18

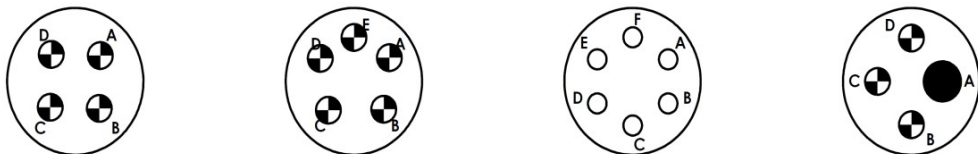

INSERT ARRANGEMENT	18-10	18-11	18-12	18-13	
SERVICE RATING	A	A	A	A	
CONTACT POSITION	ALL	ALL	ALL	ALL OTHERS	A
NO OF CONTACTS	4	5	6	3	1
CONTACT SIZE	12	12	16	12	8



# INSERT ARRANGEMENTS

Contact Legend :- 16 12 8 4 0 (AWG)

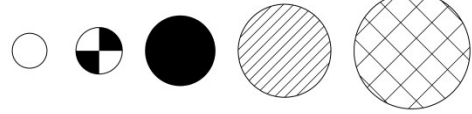

When Viewed from Face of Male Insulator

18

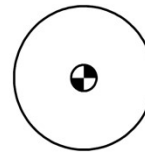
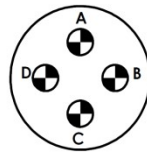
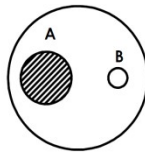

INSERT ARRANGEMENT	18-14		18-15	18-16
SERVICE RATING	A		A	C
CONTACT POSITION	ALL		ALL	ALL
NO OF CONTACTS	1	1	4	1
CONTACT SIZE	16	4	12	12

18

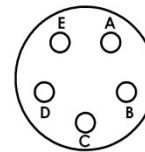
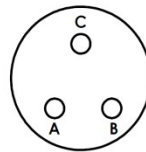
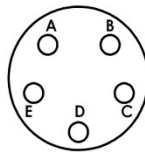

INSERT ARRANGEMENT	18-20	18-22	18-29
SERVICE RATING	A	D	A
CONTACT POSITION	ALL	ALL	ALL
NO OF CONTACTS	5	3	5
CONTACT SIZE	16	16	16

## INSERT ARRANGEMENTS

Contact Legend :- 16 12 8 4 0 (AWG)

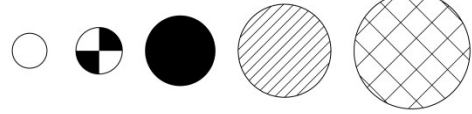

When Viewed from Face of Male Insulator

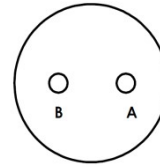
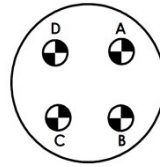
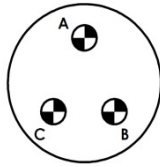
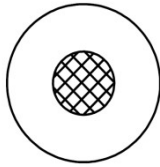

20

INSERT ARRANGEMENT	20-2	20-3	20-4	20-5
SERVICE RATING	D	D	D	E
CONTACT POSITION	ALL	ALL	ALL	ALL
NO OF CONTACTS	1	3	4	2
CONTACT SIZE	0	12	12	16

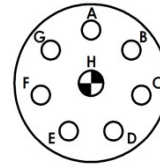
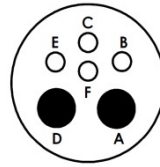
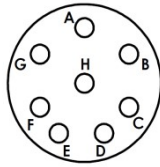
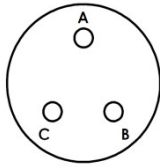

20

INSERT ARRANGEMENT	20-6	20-7		20-8		20-9	
SERVICE RATING	D	D	A	INST		D	A
CONTACT POSITION	ALL	A,B,G,H	ALL OTHERS	ALL OTHERS	A,D	H	ALL OTHERS
NO OF CONTACTS	3	4	4	4	2	1	7
CONTACT SIZE	16	16		16	8	12	16

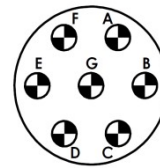
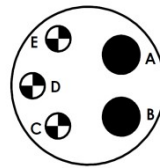
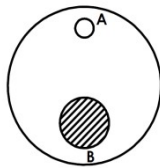
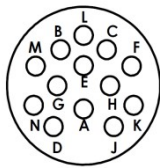

20

INSERT ARRANGEMENT	20-11	20-12		20-14		20-15
SERVICE RATING	INST	A		A		A
CONTACT POSITION	ALL	ALL		C,D,E	A,B	ALL
NO OF CONTACTS	13	1	1	3	2	7
CONTACT SIZE	16	16	4	12	8	12



# INSERT ARRANGEMENTS

Contact Legend :- 16 12 8 4 0 (AWG)

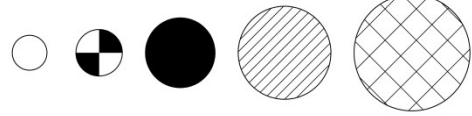

When Viewed from Face of Male Insulator

20

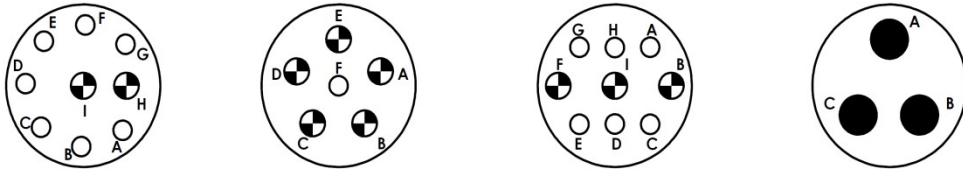

INSERT ARRANGEMENT	20-16		20-17		20-18		20-19
SERVICE RATING	A		A		A		A
CONTACT POSITION	A,B,C,D,E,F,G	H,I	F	A,B,C,D,E	A,B,C,D,E,G,H	B,F,I	ALL
NO OF CONTACTS	7	2	1	5	6	3	3
CONTACT SIZE	16	12	16	12	16	12	8

20

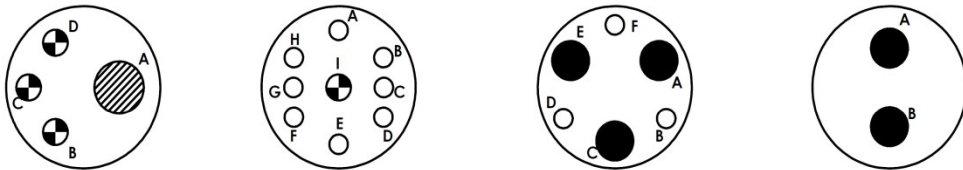

INSERT ARRANGEMENT	20-20		20-21		20-22		20-23
SERVICE RATING	A		A		A		A
CONTACT POSITION	B,C,D	A	ALL OTHERS	I	B,D,F	A,C,E	ALL
NO OF CONTACTS	3	1	8	1	3	3	2
CONTACT SIZE	12	4	16	12	16	8	8

20

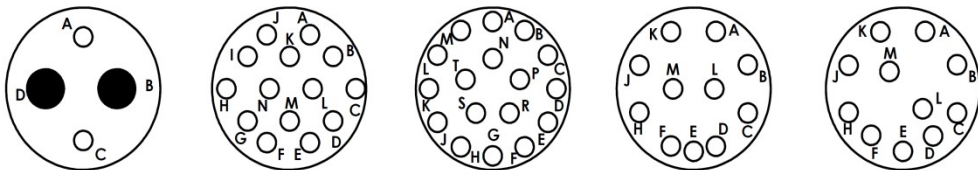

INSERT ARRANGEMENT	20-24		20-27	20-29	20-31	20-33
SERVICE RATING	A		A	A	A	A
CONTACT POSITION	A,C	B,D	ALL	ALL	ALL	ALL
NO OF CONTACTS	2	2	14	17	11	11
CONTACT SIZE	16	8	16	16	16	16



# INSERT ARRANGEMENTS

Contact Legend :- 16 12 8 4 0 (AWG)

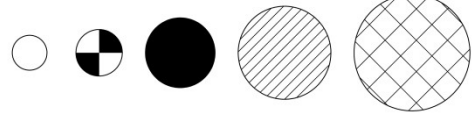

When Viewed from Face of Male Insulator

22

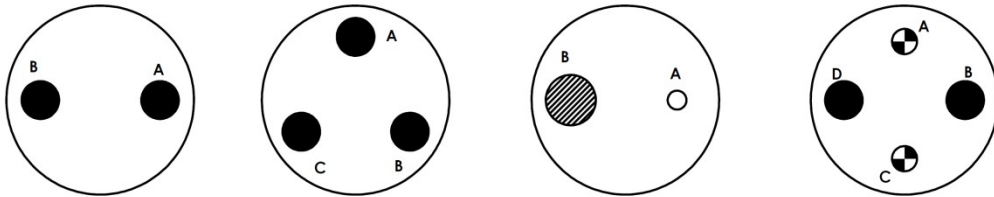

INSERT ARRANGEMENT	22-1		22-2		22-3		22-4	
SERVICE RATING	D		D		D		A	
CONTACT POSITION	ALL		ALL		A	B	A,C	B,D
NO OF CONTACTS	2		3		1	1	2	2
CONTACT SIZE	8		8		16	4	12	8

22

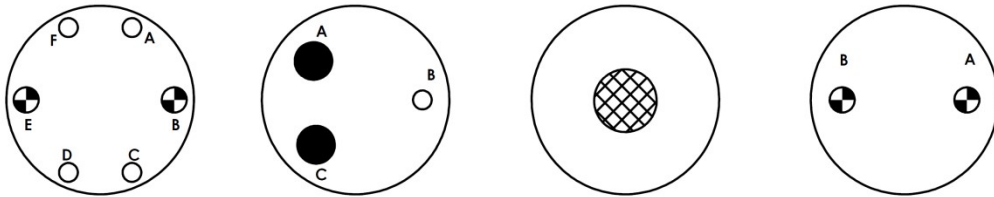

INSERT ARRANGEMENT	22-5		22-6		22-7		22-8	
SERVICE RATING	D		D		E		E	
CONTACT POSITION	A,C,D,F	B,E	B	A,C	ALL		ALL	
NO OF CONTACTS	4	2	1	2	1	2		
CONTACT SIZE	16	12	16	8	0		12	

22

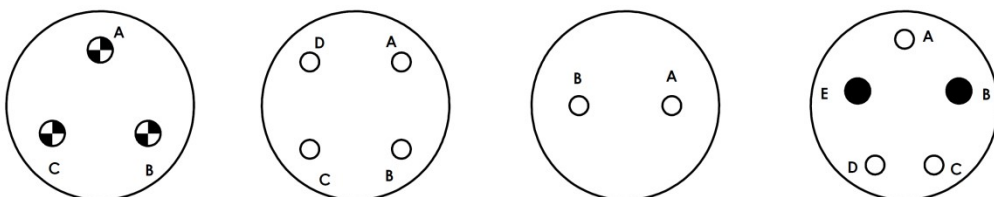

INSERT ARRANGEMENT	22-9		22-10		22-11		22-12	
SERVICE RATING	E		E		B		D	
CONTACT POSITION	ALL		ALL		ALL		A,C,D	B,E
NO OF CONTACTS	3		4		2		3	2
CONTACT SIZE	12		16		16		16	8



# INSERT ARRANGEMENTS

Contact Legend :- 16 12 8 4 0 (AWG)

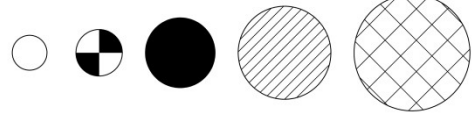

When Viewed from Face of Male Insulator

22

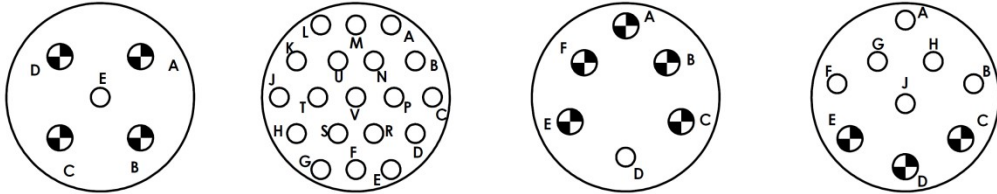

INSERT ARRANGEMENT	22-13		22-14		22-15		22-16	
SERVICE RATING	D	A	A		D	A	A	
CONTACT POSITION	E	A,B,C,D	ALL		D	ALL OTHERS	ALL OTHERS	C,D,E
NO OF CONTACTS	1	4	19		1	5	6	3
CONTACT SIZE	16	12	16		16	12	16	12

22

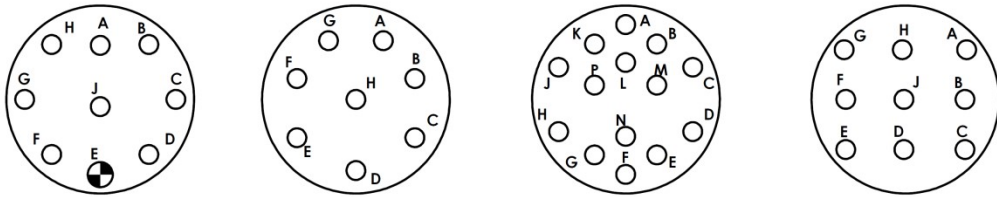

INSERT ARRANGEMENT	22-17			22-18		22-19		22-20	
SERVICE RATING	D	A	A	A	D	A		A	
CONTACT POSITION	A	B,C,D,F,G,H,J	E	C,D,E	ALL OTHERS	ALL		ALL	
NO OF CONTACTS	1	7	1	3	5	14		9	
CONTACT SIZE	16	16	12	16		16		16	

22

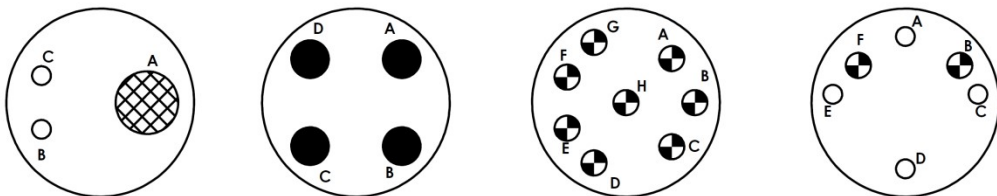

INSERT ARRANGEMENT	22-21		22-22		22-23		22-24		
SERVICE RATING	A		A		D	A	D	A	A
CONTACT POSITION	B,C	A	ALL		H	ALL OTHERS	C,D,E	A	B,F
NO OF CONTACTS	2	1	4		1	7	3	1	2
CONTACT SIZE	16	0	8		12	12	16	16	12

# INSERT ARRANGEMENTS

Contact Legend :- 16 12 8 4 0 (AWG)

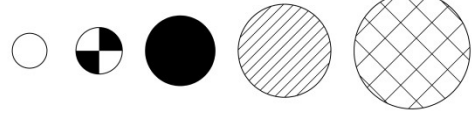

When Viewed from Face of Male Insulator

22

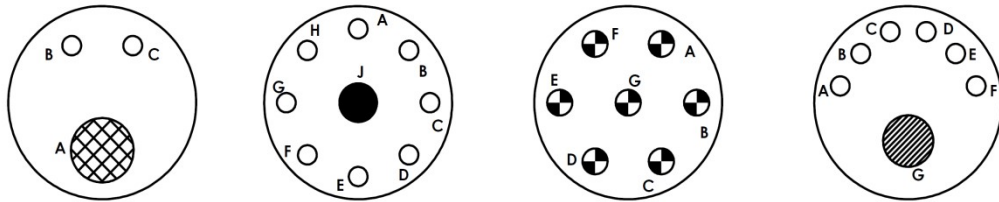

INSERT ARRANGEMENT	22-25		22-27		22-28		22-29	
SERVICE RATING	A		D	A	A		A	A
CONTACT POSITION	B,C	A	J	ALL OTHERS	ALL		ALL OTHERS	G
NO OF CONTACTS	2	1	1	8	7		6	1
CONTACT SIZE	16	0	8	16	12		16	4

22

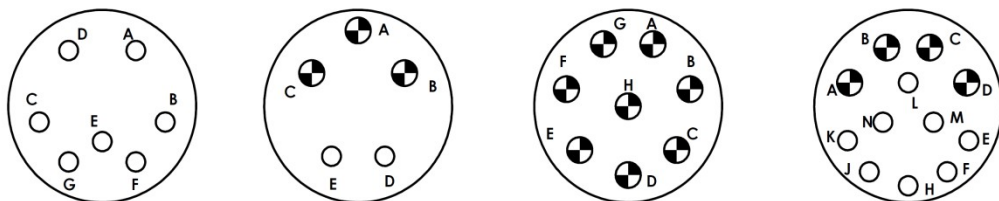

INSERT ARRANGEMENT	22-33		22-34		22-36		22-63	
SERVICE RATING	A	D	D	D	D	A	A	
CONTACT POSITION	E,F,G	A,B,C,D	D,E	A,B,C	H	ALL OTHERS	A,B,C,D	ALL OTHERS
NO OF CONTACTS	3	4	2	3	1	7	4	8
CONTACT SIZE	16	16	16	12	12	12	12	16



# INSERT ARRANGEMENTS

Contact Legend :- 16 12 8 4 0 (AWG)

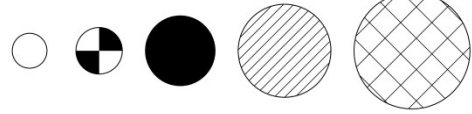

When Viewed from Face of Male Insulator

24

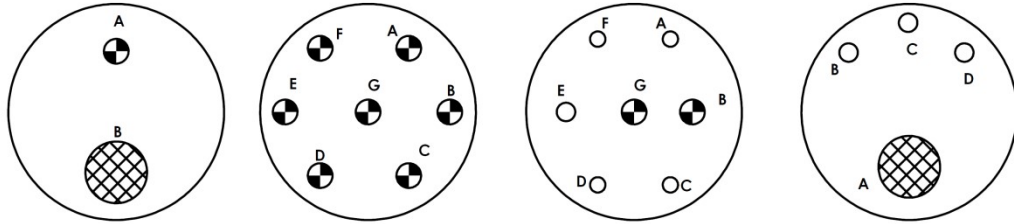

INSERT ARRANGEMENT	24-1		24-2		24-3		24-4	
SERVICE RATING	D	D	D	D	D	D	D	D
CONTACT POSITION	A	B	ALL	ALL	A,C,D,E,F	B,G	B,C,D	A
NO OF CONTACTS	1	1	7	5	2	3	1	
CONTACT SIZE	12	0	12	16	12	16	0	

24

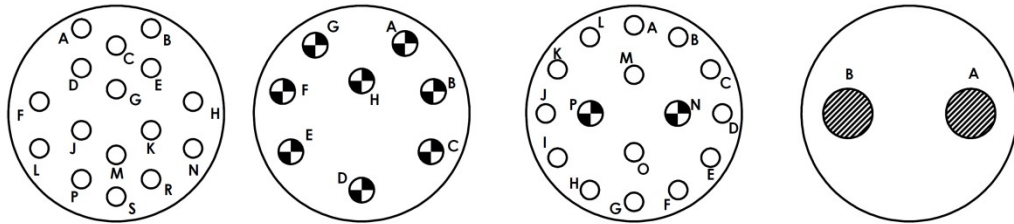

INSERT ARRANGEMENT	24-5		24-6		24-7		24-9	
SERVICE RATING	A	A	D	A	A	A	A	A
CONTACT POSITION	ALL	ALL	A,G,H	ALL OTHERS	ALL OTHERS	P,N	ALL	ALL
NO OF CONTACTS	16	16	3	5	14	2	2	2
CONTACT SIZE	16	16	12	12	16	12	4	

24

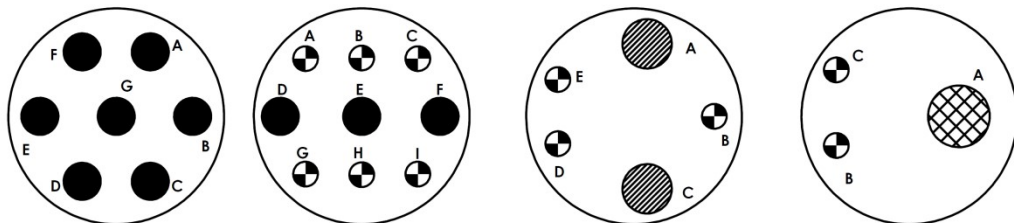

INSERT ARRANGEMENT	24-10		24-11		24-12		24-14	
SERVICE RATING	A	A	A	A	A	A	A	A
CONTACT POSITION	ALL	ALL	ALL OTHERS	D,E,F	ALL OTHERS	A,C	B,C	A
NO OF CONTACTS	7	6	3	3	2	2	1	
CONTACT SIZE	8	12	8	12	4	12	0	

# INSERT ARRANGEMENTS

Contact Legend :- 16 12 8 4 0 (AWG)

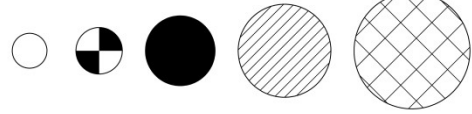

When Viewed from Face of Male Insulator

24

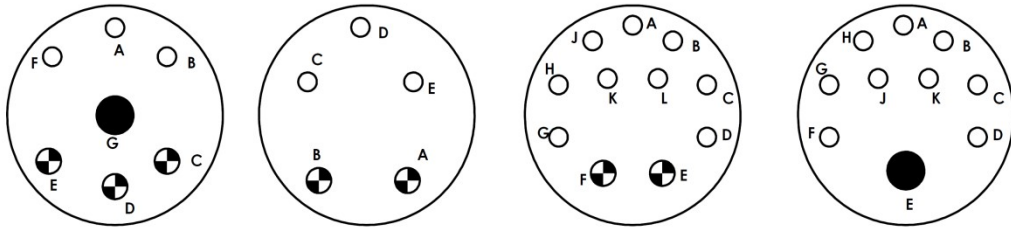

INSERT ARRANGEMENT	24-16			24-17		24-20		24-21	
SERVICE RATING	D	D	A	D		D		D	
CONTACT POSITION	A,B,F	G	C,D,E	C,D,E	A,B	ALL OTHERS	F,E	ALL OTHERS	E
NO OF CONTACTS	3	1	3	3	2	9	2	9	1
CONTACT SIZE	16	8	12	16	12	16	12	16	8

24

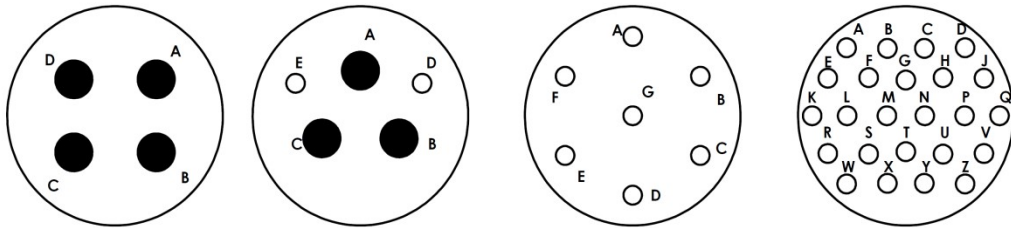

INSERT ARRANGEMENT	24-22	24-23		24-27	24-28
SERVICE RATING	A	D		E	INT
CONTACT POSITION	ALL	D,E	A,B,C	ALL	ALL
NO OF CONTACTS	4	2	3	7	24
CONTACT SIZE	8	16	8	16	16

24

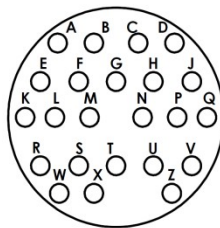

INSERT ARRANGEMENT	24-80
SERVICE RATING	INST
CONTACT POSITION	ALL
NO OF CONTACTS	23
CONTACT SIZE	16



# INSERT ARRANGEMENTS

Contact Legend :- 16 12 8 4 0 (AWG)

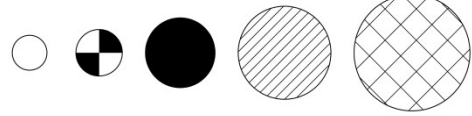

When Viewed from Face of Male Insulator

28

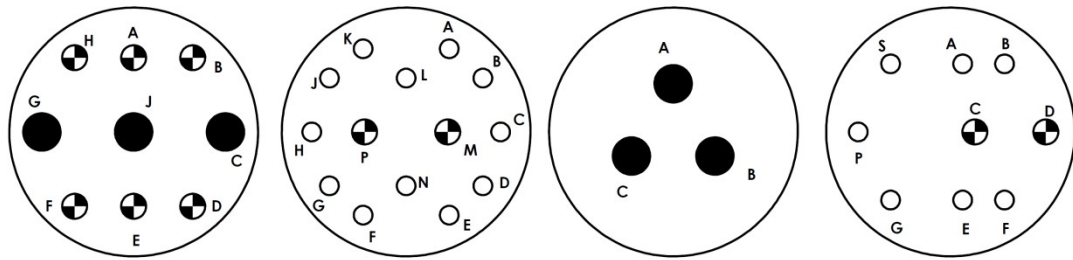

INSERT ARRANGEMENT	28-1				28-2		28-3	28-4		
SERVICE RATING	D	A	D	A	D		E	E	D	D
CONTACT POSITION	A,E	B,D,F,H	J	G,C	ALL OTHERS	M,P	ALL	G,P,S	A,B,E,F	C,D
NO OF CONTACTS	2	4	1	2	12	2	3	3	4	2
CONTACT SIZE	12	12	8	8	16	12	8	16	16	12

28

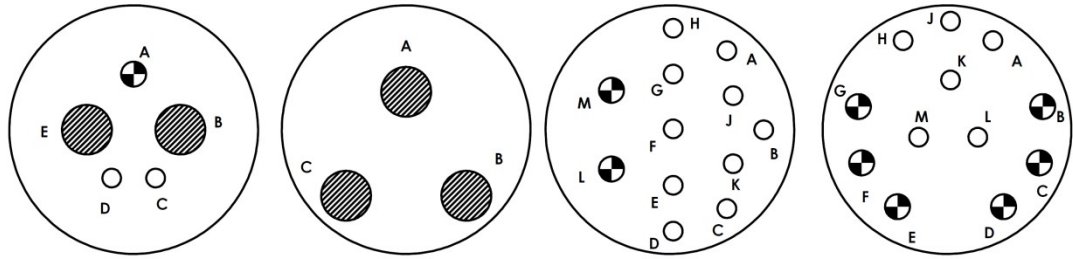

INSERT ARRANGEMENT	28-5			28-6	28-8			28-9	
SERVICE RATING	D	D	D	D	E	D	A	D	
CONTACT POSITION	C,D	A	B,E	ALL	L,M	B	ALL OTHERS	A,H,J,K,L,M	B,C,D,E,F,G
NO OF CONTACTS	2	1	2	3	2	1	9	6	6
CONTACT SIZE	16	12	4	4	12	16	16	16	12

28

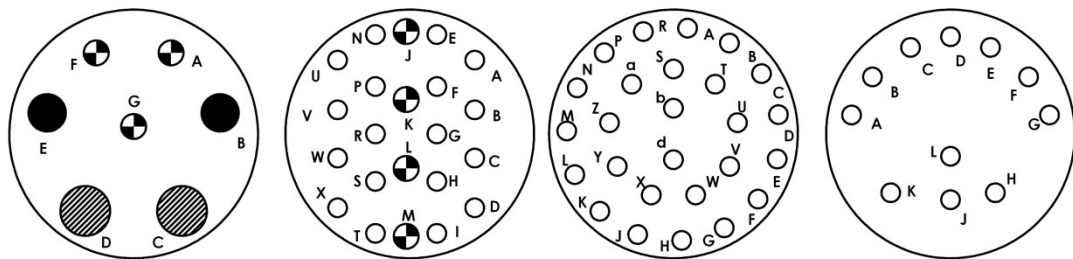

INSERT ARRANGEMENT	28-10				28-11		28-12	28-14
SERVICE RATING	D	A	A	A	A	A	D	
CONTACT POSITION	G	A,F	B,E	C,D	ALL OTHERS	J,K,L,M	ALL	
NO OF CONTACTS	1	2	2	2	18	4	11	
CONTACT SIZE	12	12	8	4	16	12	16	

# INSERT ARRANGEMENTS

Contact Legend :- 16 12 8 4 0 (AWG)

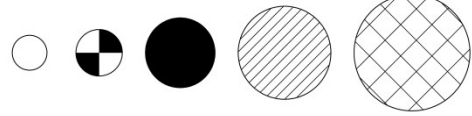

When Viewed from Face of Male Insulator

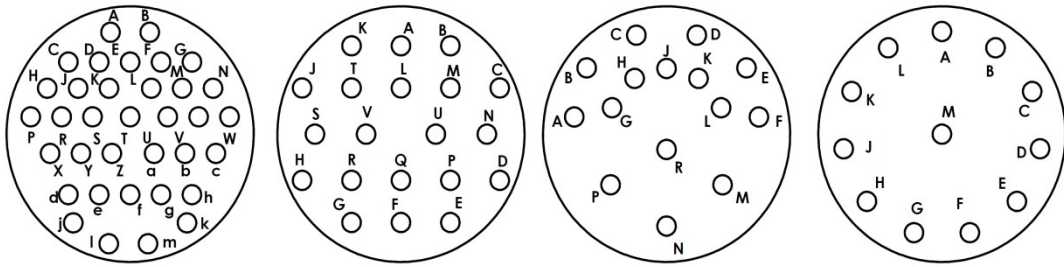

28

INSERT ARRANGEMENT	28-15	28-16	28-17			28-18			
SERVICE RATING	A	A	B	D	A	C	A	INST	D
CONTACT POSITION	ALL	ALL	R	M,N,P	ALL OTHERS	M	A,B	C,D,E,F	ALL OTHERS
NO OF CONTACTS	35	20	1	3	11	1	2	4	5
CONTACT SIZE	16	16	16			16			

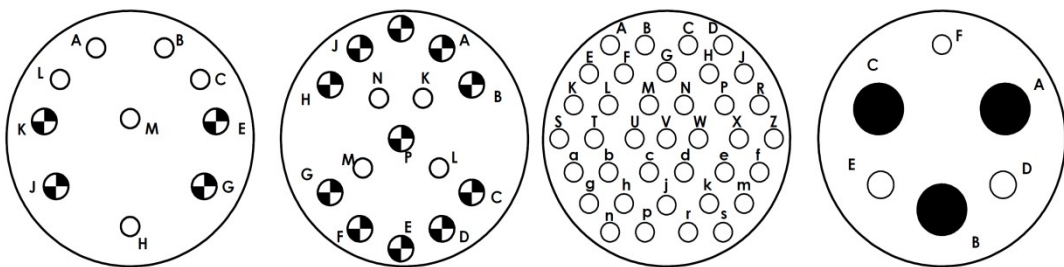

28

INSERT ARRANGEMENT	28-19				28-20		28-21	28-22	
SERVICE RATING	B	D	A		A		A	D	
CONTACT POSITION	H,M	A,B	C,L	E,G,J,K	K,L,M,N	ALL OTHERS	ALL	E,F,D	A,B,C
NO OF CONTACTS	2	2	2	4	4	10	37	3	3
CONTACT SIZE	16	16	16	12	16	12	16	16	4



# INSERT ARRANGEMENTS

Contact Legend :- 16 12 8 4 0 (AWG)

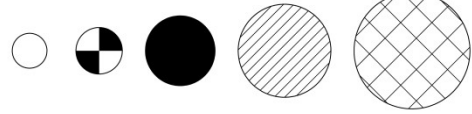

When Viewed from Face of Male Insulator

32

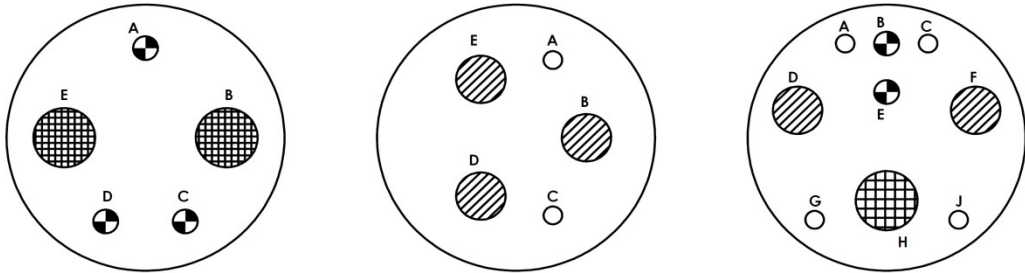

INSERT ARRANGEMENT	32-1		32-2		32-3			
SERVICE RATING	D	E	E		D			
CONTACT POSITION	All Other	A	All		All			
NO OF CONTACTS	3	2	2	3	4	2	2	1
CONTACT SIZE	12	0	16	4	16	12	4	0

32

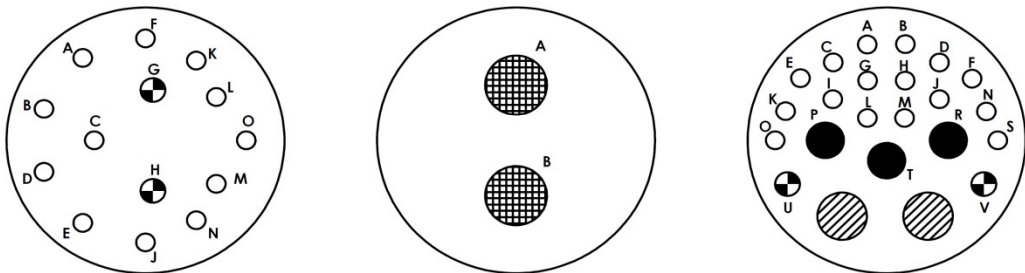

INSERT ARRANGEMENT	32-4		32-5		32-6			
SERVICE RATING	D	A	E		A			
CONTACT POSITION	All Other	O,P,S,R,T,U,V	All		All			
NO OF CONTACTS	12	2	2		16	2	3	2
CONTACT SIZE	16	12	0		16	12	8	4

32

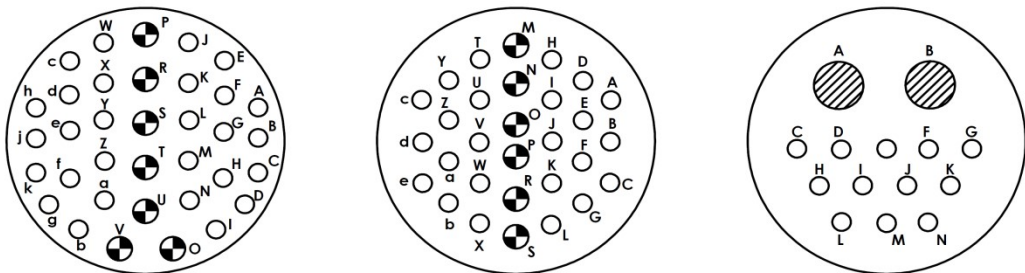

INSERT ARRANGEMENT	32-7		32-8		32-9	
SERVICE RATING	INST	A	A		D	
CONTACT POSITION	All Other	O,P,S,R,T,U,V	All		All	
NO OF CONTACTS	28	7	24	6	12	2
CONTACT SIZE	16	12	16	12	16	4



# INSERT ARRANGEMENTS

Contact Legend :- 16 12 8 4 0  
(AWG)

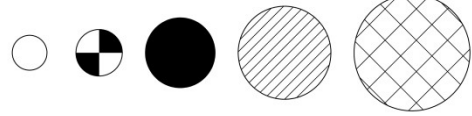

When Viewed from Face of Male Insulator

32

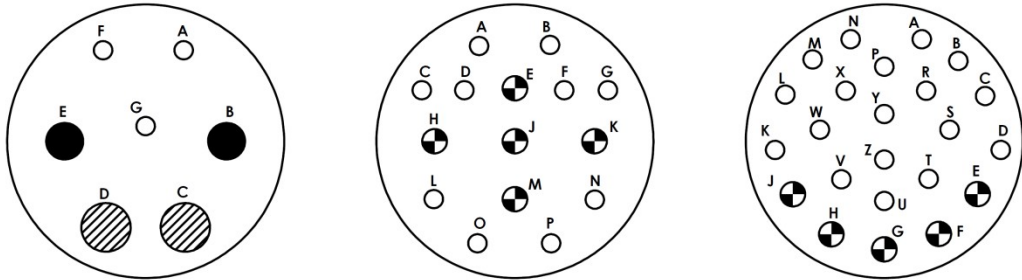

INSERT ARRANGEMENT	32-10				32-12		32-13	
SERVICE RATING	E	B	D	A	A	D	D	
CONTACT POSITION	E, F	G	BE	CD	E, C, D, F, G	All Others	All	
NO OF CONTACTS	3	2	2		10	5	18	5
CONTACT SIZE	16	8	4		16	12	16	12

32

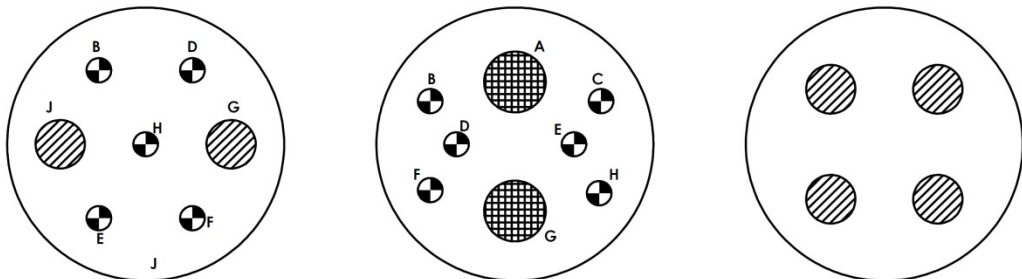

INSERT ARRANGEMENT	32-14		32-15		32-17	
SERVICE RATING	D		D		D	
CONTACT POSITION	All		All		All	
NO OF CONTACTS	5	4	6	2	4	
CONTACT SIZE	12	2	12	0	4	

32

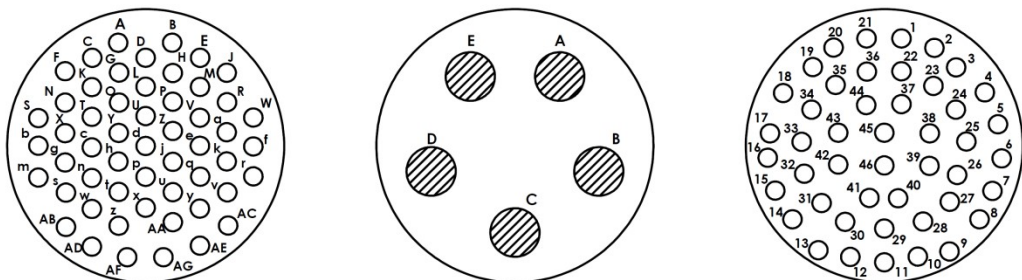

INSERT ARRANGEMENT	32-22		32-63		32-73	
SERVICE RATING	A		D		A	
CONTACT POSITION	All		All		All	
NO OF CONTACTS	54		5		46	
CONTACT SIZE	16		4		16	



# INSERT ARRANGEMENTS

Contact Legend :- 16 12 8 4 0 (AWG)

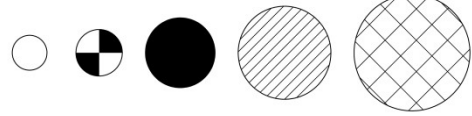

When Viewed from Face of Male Insulator

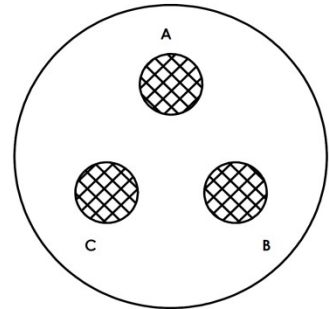
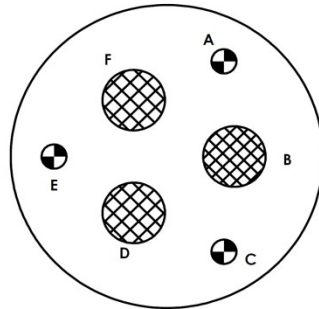
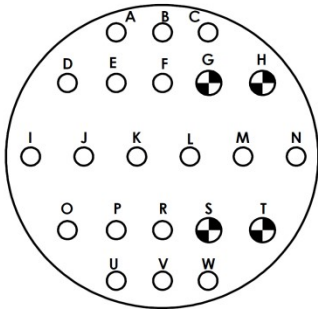

36

INSERT ARRANGEMENT	36-1		36-3		36-4	
SERVICE RATING	D	D	D	D	D	A
CONTACT POSITION	ALL OTHERS	G,H,S,T	A,C,E	B,D,F	A	B,C
NO OF CONTACTS	18	4	3	3	1	2
CONTACT SIZE	16	12	12	0	0	

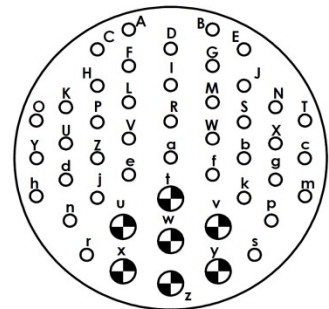
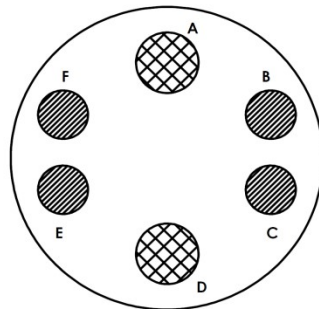
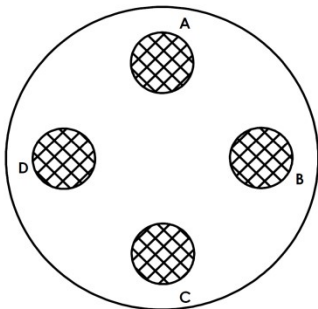

36

INSERT ARRANGEMENT	36-5		36-6		36-7	
SERVICE RATING	A		A		A	A
CONTACT POSITION	ALL		ALL OTHERS	A,D	ALL OTHERS	t,u,v,w,x,y,z
NO OF CONTACTS	4		4	2	40	7
CONTACT SIZE	0		4	0	16	12

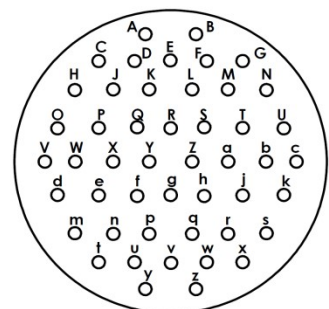
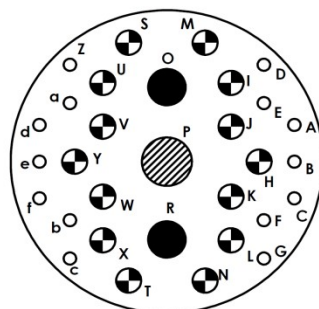
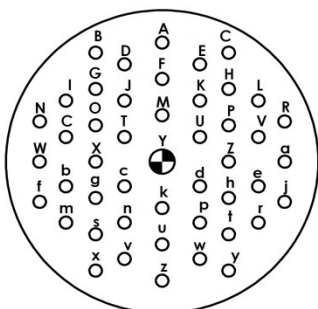

36

INSERT ARRANGEMENT	36-8		36-9				36-10	
SERVICE RATING	A	A	A	A	A	A	A	
CONTACT POSITION	ALL OTHERS	Y	ALL OTHERS	H,I,J,K,L,M,N,S,T,U,V,Y,W,X	O,R	P	ALL	
NO OF CONTACTS	46	1	14	14	2	1	48	
CONTACT SIZE	16	12	16	12	8	4	16	

# INSERT ARRANGEMENTS

Contact Legend :- 16 12 8 4 0 (AWG)

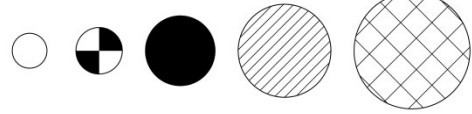

When Viewed from Face of Male Insulator

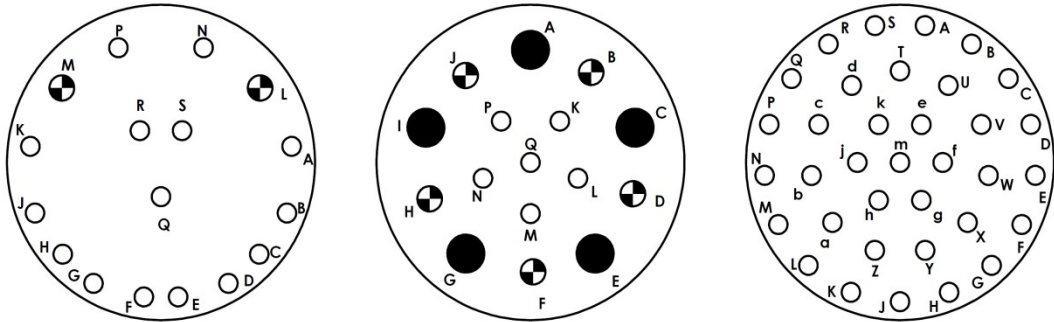

36

INSERT ARRANGEMENT	36-13			36-14			36-15	
SERVICE RATING	E	A	A	D	D	D	D	A
CONTACT POSITION	N,P,Q	ALL OTHERS	M,L	ALL OTHERS	B,D,F,H,G	A,C,E,G,I	M	ALL OTHERS
NO OF CONTACTS	3	12	2	6	5	5	35	
CONTACT SIZE	16		12	16	12	8	16	

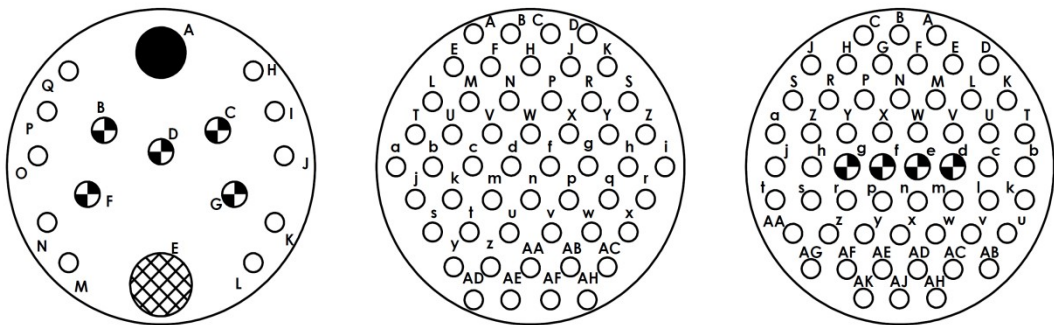

36

INSERT ARRANGEMENT	36-19				36-52				36-66	
SERVICE RATING	D	D	D	D	A				A	
CONTACT POSITION	ALL OTHERS	B,C,D,F,G	A	E	ALL				ALL OTHERS	g,f,e,d
NO OF CONTACTS	10	5	1	1	52				52	4
CONTACT SIZE	16	12	4	0	16				16	12



## INSERT ORIENTATION

□ When viewed from face of male insulator.

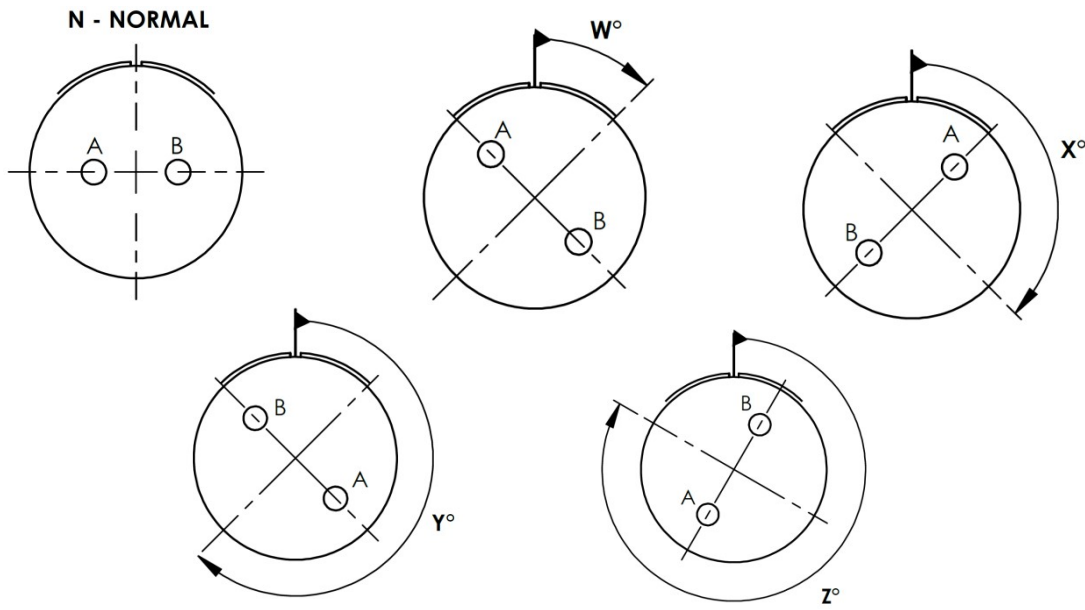

Shell	Layout	ALTERNATE POSITIONS (DEGREES)			
		W	X	Y	Z
10SL	3	---	---	---	---
	4	63	---	---	---
12S	3	70	145	215	290
	4	---	---	---	---
14S	1	---	---	---	---
	2	---	120	240	---
	3	---	---	---	---
	4	---	---	---	---
	5	---	110	---	---
	6	---	---	---	---
	7	90	180	270	---
	9	70	145	215	290
16S	1	80	---	---	280
	3	---	---	---	---
	4	35	110	250	325
	5	70	145	215	290
	6	90	180	270	---
	7	80	110	250	280
	8	---	170	265	---

## INSERT ORIENTATION

Shell	Layout	ALTERNATE POSITIONS (DEGREES)			
		W	X	Y	Z
	1	70	145	215	290
	3	35	110	250	325
	4	35	110	250	325
	5	80	110	250	280
	6	---	---	---	---
	7	---	---	---	---
	8	70	---	---	290
	18	9	80	110	250
10		---	120	240	---
11		---	170	265	---
12		80	---	---	280
13		80	110	250	280
14		80	110	250	280
15		---	120	240	---
16		---	---	---	---
20		90	180	270	---
22		70	145	215	290
29		90	180	270	---

## INSERT ORIENTATION

Shell	Layout	ALTERNATE POSITIONS (DEGREES)			
		W	X	Y	Z
20	2	---	---	---	---
	3	70	145	215	290
	4	45	110	250	---
	5	35	110	250	325
	6	70	145	215	290
	7	80	110	250	280
	8	80	110	250	280
	9	80	110	250	280
	11	---	---	---	---
	12	80	110	250	280
	14	80	110	250	280
	15	80	---	---	280
	16	80	110	250	280
	17	90	180	270	---
	18	35	110	250	325
	19	90	180	270	---
	20	80	110	250	280
	21	35	110	250	325
	22	80	110	250	280
	23	35	110	250	325
	24	35	110	250	325
	27	35	110	250	325
29	80	---	---	280	
31	---	---	---	---	
33	---	---	---	---	
22	1	35	110	250	325
	2	70	145	215	290
	3	80	110	250	280
	4	35	110	250	325
	5	35	110	250	325
	6	35	110	250	325
	7	---	---	---	---
	8	35	110	250	325
	9	70	145	215	290
	10	35	110	250	325
	11	35	110	250	325
	12	80	110	250	280

## INSERT ORIENTATION

Shell	Layout	ALTERNATE POSITIONS (DEGREES)			
		W	X	Y	Z
22	13	35	110	250	325
	14	80	110	250	280
	15	80	110	250	280
	16	80	110	250	280
	17	80	110	250	280
	18	80	110	250	280
	19	80	110	250	280
	20	35	110	250	325
	21	80	110	250	280
	22	---	110	250	---
	23	35	---	250	---
	24	80	110	250	280
	25	80	110	250	280
	27	80	---	250	280
	28	80	---	---	280
	29	80	110	250	280
	33	80	110	250	280
	34	80	110	250	280
36	90	---	270	---	
63	20	---	---	---	
24	1	80	110	250	280
	2	80	---	---	280
	3	80	110	250	280
	4	80	110	250	280
	5	80	110	250	280
	6	80	110	250	280
	7	80	110	250	280
	9	35	110	250	325
	10	80	---	---	280
	11	35	110	250	325
	12	80	110	250	280
	14	80	110	250	280
	16	80	110	250	280
	17	80	110	250	280
	20	80	110	250	280
	21	80	110	250	280
	22	45	110	250	---
	23	80	110	250	280
27	80	---	---	280	

## INSERT ORIENTATION

Shell	Layout	ALTERNATE POSITIONS (DEGREES)			
		W	X	Y	Z
24	28	80	110	250	280
	80	35	145	240	300
28	1	80	110	250	280
	2	35	110	250	325
	3	70	145	215	290
	4	80	110	250	280
	5	35	110	250	325
	6	70	145	215	290
	8	80	110	250	280
	9	80	110	250	280
	10	80	110	250	280
	11	80	110	250	280
	12	90	180	270	---
	14	80	110	250	280
	15	80	110	250	280
	16	80	110	250	280
	17	80	110	250	280
	18	70	145	215	290
	19	80	110	250	280
	20	80	110	250	280
	21	80	110	250	280
	22	70	145	215	290
	32	1	80	110	250
2		70	145	215	290
3		80	110	250	280
4		80	110	250	280
5		80	110	250	280
6		80	110	250	280
7		80	125	235	280
8		80	125	235	280
9		80	110	250	280
10		80	110	250	280
12		80	110	250	280
13		80	110	250	280
14		35	110	250	325
15		35	110	250	280
17		45	110	250	---
22	80	110	250	280	



## INSERT ORIENTATION

Shell	Layout	ALTERNATE POSITIONS (DEGREES)			
		W	X	Y	Z
32	63	---	---	---	---
	73	36	---	---	---
36	1	80	110	250	280
	3	70	145	215	290
	4	70	145	215	290
	5	---	120	240	---
	6	35	110	250	325
	7	80	110	250	280
	8	80	110	250	280
	9	80	125	235	280
	10	80	125	235	280
	13	80	110	250	280
	14	90	180	270	---
	15	60	125	245	305
	19	80	110	250	280
	52	72	144	216	288
	66	110	250	260	280

## TBS3100R SERIES

### ➤ Wall Mount Receptacle with Short Endbell.

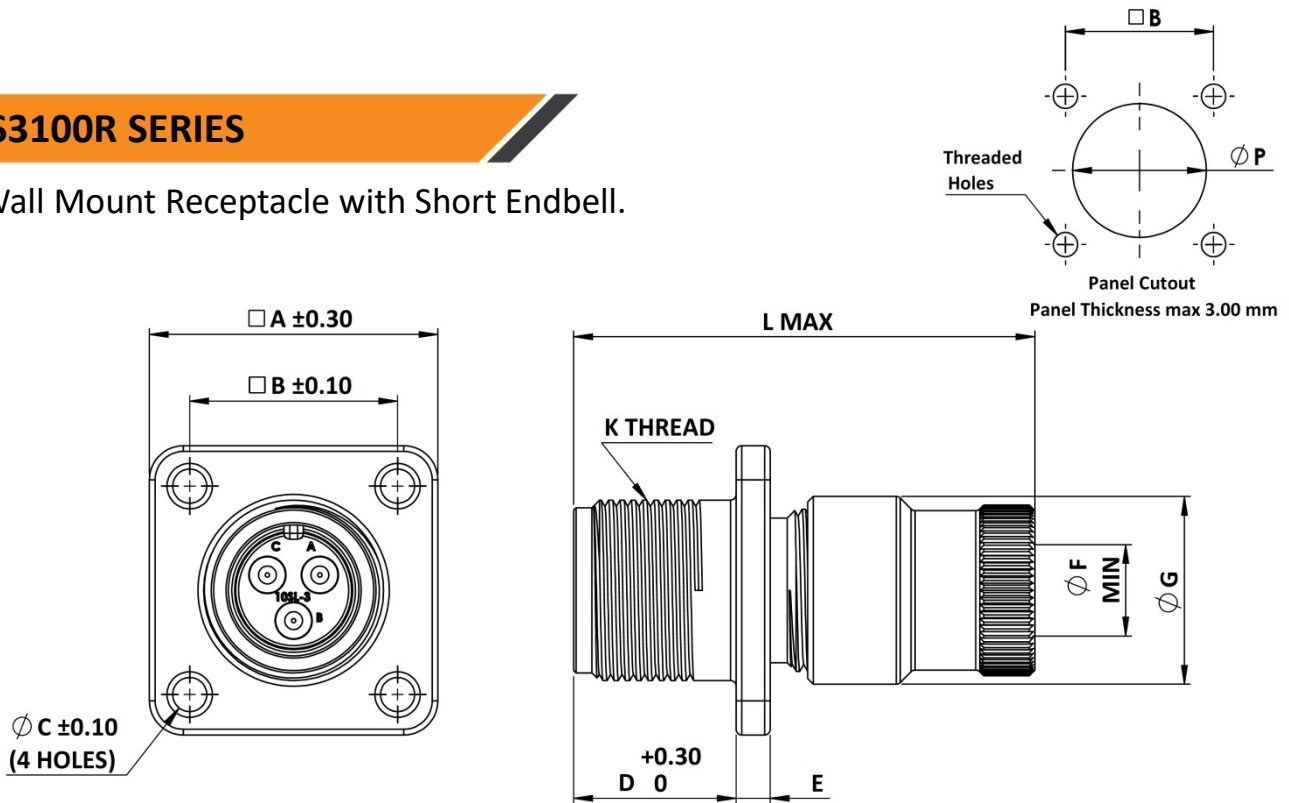

SHELL SIZE	A	B	K (UNEF 2A)	C	D	E MAX	F	G	L	P
<b>10SL</b>	25.40	18.30	5/8 - 24	3.00	14.30	4.00	4.37	17.50	46.60	18.50
<b>12S</b>	27.80	20.60	3/4 - 20	3.00	14.30	4.00	7.14	20.50	46.60	21.50
<b>14S</b>	30.20	23.00	7/8 - 20	3.00	14.30	4.00	10.31	22.50	46.60	23.50
<b>16S</b>	32.50	24.60	1 - 20	3.00	14.30	4.00	12.70	25.50	46.60	26.50
<b>18</b>	34.90	27.00	1-1/8 - 18	3.00	19.10	5.20	13.49	28.50	57.90	29.50
<b>20</b>	38.10	29.40	1-1/4 - 18	3.00	19.10	5.20	16.66	32.50	57.90	33.50
<b>22</b>	41.30	31.80	1-3/8 - 18	3.00	19.10	5.20	19.05	35.50	57.90	36.50
<b>24</b>	44.50	34.90	1-1/2 - 18	3.70	20.60	5.20	19.84	41.50	57.90	42.50
<b>28</b>	50.80	39.70	1-3/4 - 18	3.70	20.60	5.20	23.42	44.50	57.90	45.50
<b>32</b>	57.20	44.50	2 - 18 UNS	4.40	22.20	9.10	29.36	49.50	58.90	50.50
<b>36</b>	63.50	49.20	2-1/4 - 16 UN	4.40	22.20	9.10	31.75	54.50	58.90	55.50

All dimensions are in mm.

Specifications & Dimensions subject to change.

## TBS3100F SERIES

### ➤ Wall Mounting Receptacle with Strain Relief Cable Clamp.

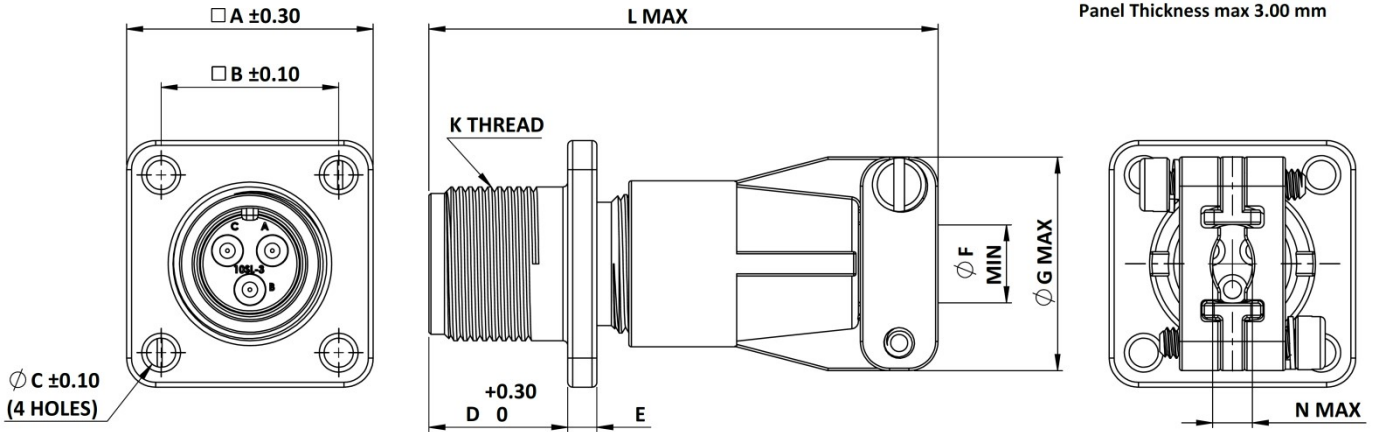
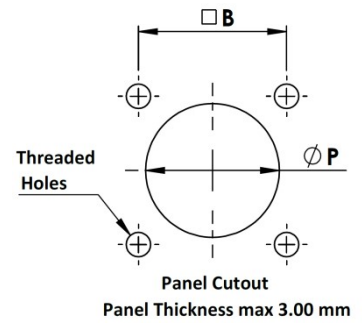

SHELL SIZE	A	B	K (UNEF 2A)	C	D	E MAX	F (CABLE CLEARANCE)	N (CLOSED)	G	L	P
<b>10SL</b>	25.40	18.30	5/8 - 24	3.00	14.30	4.00	4.37	5.08	28.50	58.70	18.50
<b>12S</b>	27.80	20.60	3/4 - 20	3.00	14.30	4.00	7.14	5.08	28.50	58.70	21.50
<b>14S</b>	30.20	23.00	7/8 - 20	3.00	14.30	4.00	10.31	7.92	34.10	58.70	23.50
<b>16S</b>	32.50	24.60	1 - 20	3.00	14.30	4.00	12.70	9.14	37.60	58.70	26.50
<b>18</b>	34.90	27.00	1-1/8 - 18	3.00	19.10	5.20	13.49	10.72	40.80	70.60	29.50
<b>20</b>	38.10	29.40	1-1/4 - 18	3.00	19.10	5.20	16.66	13.49	48.00	70.60	33.50
<b>22</b>	41.30	31.80	1-3/8 - 18	3.00	19.10	5.20	19.05	13.49	48.00	70.60	36.50
<b>24</b>	44.50	34.90	1-1/2 - 18	3.70	20.60	5.20	19.84	15.09	67.40	75.40	42.50
<b>28</b>	50.80	39.70	1-3/4 - 18	3.70	20.60	5.20	23.42	15.09	67.40	77.00	45.50
<b>32</b>	57.20	44.50	2 - 18 UNS	4.40	22.20	9.10	29.36	20.07	67.40	80.00	50.50
<b>36</b>	63.50	49.20	2-1/4 - 16 UN	4.40	22.20	9.10	31.75	20.07	74.10	80.00	55.50

All dimensions are in mm.  
Specifications & Dimensions subject to change.



## TBS3101F SERIES

- Cable Connecting Receptacle with Strain Relief Cable Clamp.

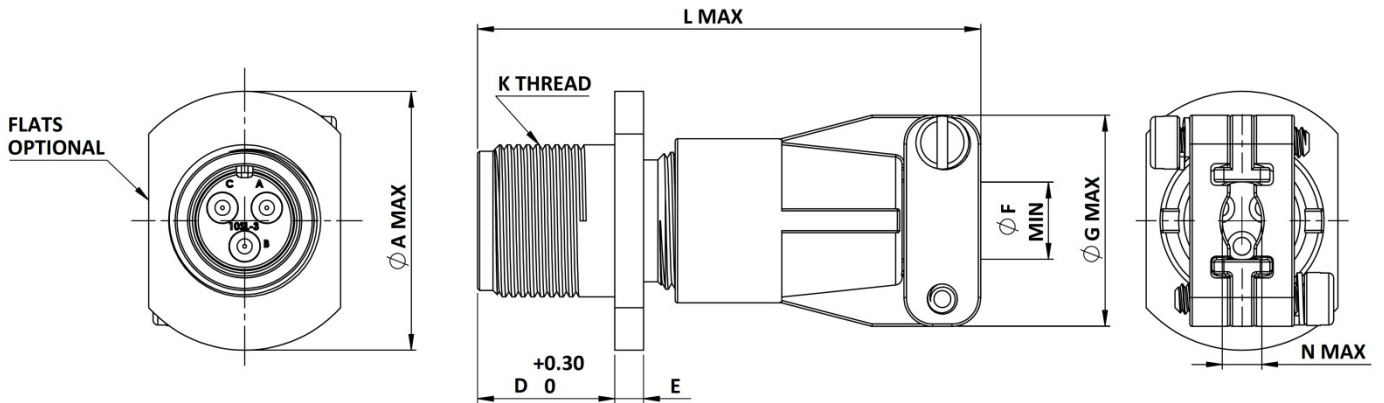

SHELL SIZE	A	K (UNEF 2A)	D	E MAX	F	N (CLOSED)	G	L
<b>10SL</b>	26.90	5/8 - 24	14.30	4.00	4.37	5.08	17.50	57.15
<b>12S</b>	26.90	3/4 - 20	14.30	4.00	7.14	5.08	20.50	57.15
<b>14S</b>	29.30	7/8 - 20	14.30	4.00	10.31	7.92	22.50	57.15
<b>16S</b>	32.50	1 - 20	14.30	4.00	12.70	9.14	25.50	57.15
<b>18</b>	34.10	1-1/8 - 18	19.10	5.20	13.49	10.72	28.50	68.28
<b>20</b>	38.10	1-1/4 - 18	19.10	5.20	16.66	13.49	32.50	69.85
<b>22</b>	41.20	1-3/8 - 18	19.10	5.20	19.05	13.49	35.50	69.85
<b>24</b>	44.40	1-1/2 - 18	20.60	5.20	19.84	15.09	41.50	75.44
<b>28</b>	50.80	1-3/4 - 18	20.60	5.20	23.42	15.09	44.50	77.00
<b>32</b>	57.10	2 - 18 UNS	22.20	9.10	29.36	20.07	49.50	80.00
<b>36</b>	63.50	2 - 1/4 - 16 UN	22.20	9.10	31.75	20.07	54.50	80.00

All dimensions are in mm.  
Specifications & Dimensions subject to change.

## TBS3102R SERIES

### ➤ Box Mounting Receptacle.

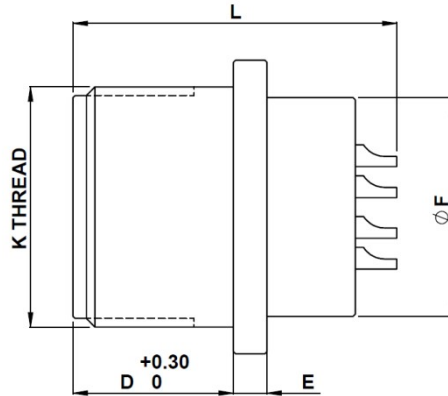
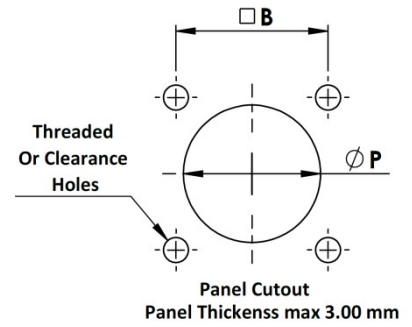
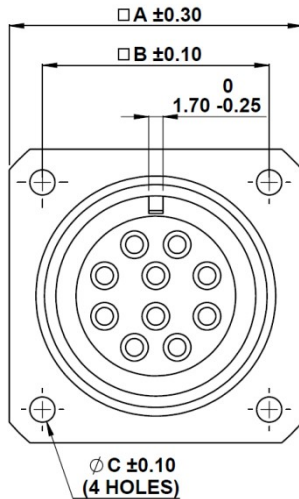

SHELL SIZE	A	B	K (UNEF 2A)	C	D	E Max	F MAX	L MAX	P
<b>10SL</b>	25.40	18.30	5/8 - 24	3.00	14.30	4.00	15.50	30.20	16.80
<b>12S</b>	27.80	20.60	3/4 - 20	3.00	14.30	4.00	17.50	30.20	20.00
<b>14S</b>	30.20	23.00	7/8 - 20	3.00	14.30	4.00	20.00	30.20	23.25
<b>16S</b>	32.50	24.60	1 - 20	3.00	14.30	4.00	23.00	30.20	26.40
<b>18</b>	34.90	27.00	1-1/8 - 18	3.00	19.10	5.20	26.50	49.20	29.50
<b>20</b>	38.10	29.40	1-1/4 - 18	3.00	19.10	5.20	29.50	49.20	32.75
<b>22</b>	41.30	31.80	1-3/8 - 18	3.00	19.10	5.20	32.50	49.20	35.90
<b>24</b>	44.50	34.90	1-1/2 - 18	3.70	20.60	5.20	35.50	49.20	39.10
<b>28</b>	50.80	39.70	1-3/4 - 18	3.70	20.60	5.20	42.00	49.20	45.50
<b>32</b>	57.20	44.50	2 - 18 UNS	4.40	22.20	9.10	47.50	49.20	51.80
<b>36</b>	63.50	49.20	2 -1/4 - 16 UN	4.40	22.20	9.10	54.00	49.20	58.15

All dimensions are in mm.  
Specifications & Dimensions subject to change.



## TBS3106F SERIES

➤ Straight Plug Connector with Strain Relief Cable Clamp.

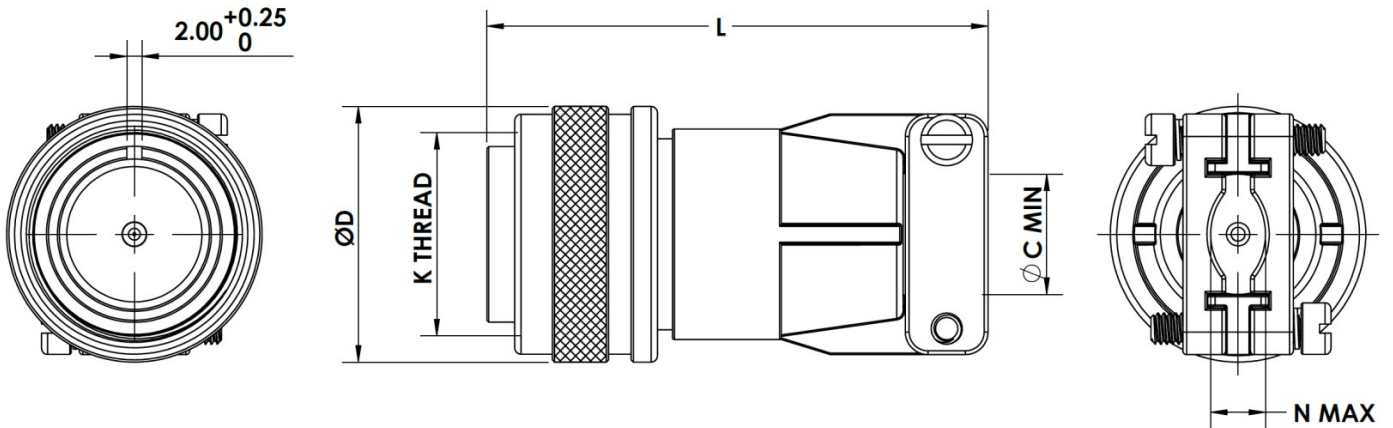

SHELL SIZE	K (UNEF 2B)	D Max	L Max	N (CLOSED)	C (CABLE CLEARANCE)
10SL	5/8 - 24	24.61	58.70	5.08	4.37
12S	3/4 - 20	26.97	58.70	5.08	7.14
14S	7/8 - 20	29.36	58.70	7.92	10.31
16S	1 - 20	31.75	58.70	9.14	12.70
18	1-1/8 - 18	34.14	70.60	10.72	13.49
20	1-1/4 - 18	37.31	70.60	13.49	16.66
22	1-3/8 - 18	40.49	70.60	13.49	19.05
24	1-1/2 - 18	43.66	75.40	15.09	19.84
28	1-3/4 - 18	50.01	77.00	15.09	23.42
32	2 - 18 UNS	56.36	80.00	20.07	29.36
36	2-1/4 - 16 UN	62.71	80.00	20.07	31.75

All dimensions are in mm.  
Specifications & Dimensions subject to change.

## TBS3108F SERIES

➤ Plug Connector with 90° Strain Relief Cable Clamp.

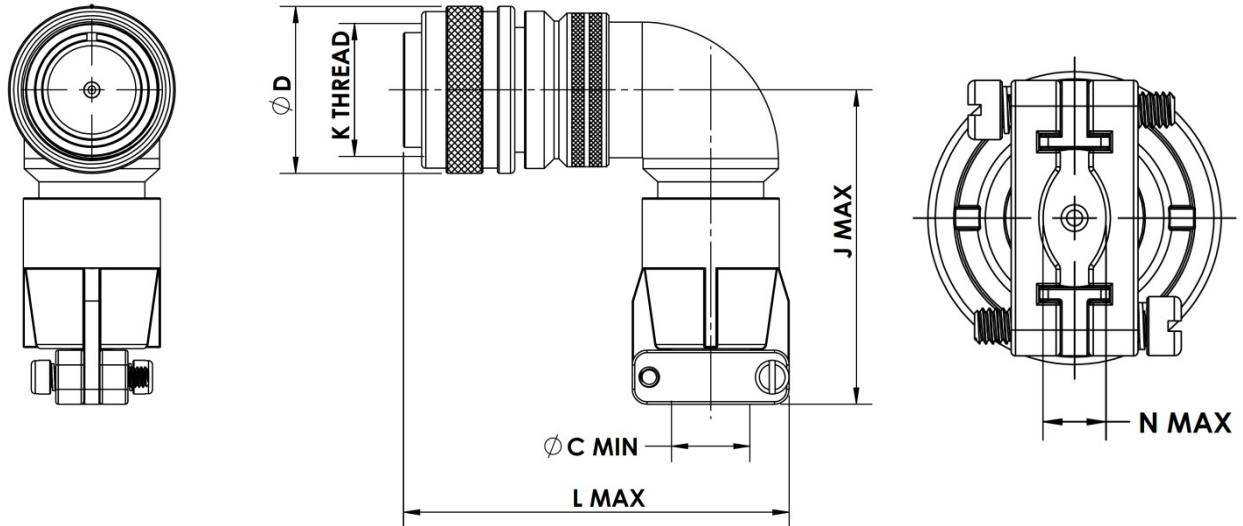

SHELL SIZE	K (UNEF 2B)	D	L	J	N (CLOSED)	C (CABLE CLEARANCE)
<b>10SL</b>	5/8 - 24	24.61	58.70	38.10	5.08	4.37
<b>12S</b>	3/4 - 20	26.97	58.70	38.10	5.08	7.14
<b>14S</b>	7/8 - 20	29.36	58.70	40.48	7.92	10.31
<b>16S</b>	1 - 20	31.75	58.70	42.87	9.14	12.70
<b>18</b>	1-1/8 - 18	34.14	70.60	45.23	10.72	13.49
<b>20</b>	1-1/4 - 18	37.31	70.60	50.01	13.49	16.66
<b>22</b>	1-3/8 - 18	40.49	70.60	50.80	13.49	19.05
<b>24</b>	1-1/2 - 18	43.66	75.40	53.97	15.09	19.84
<b>28</b>	1-3/4 - 18	50.01	77.00	55.57	15.09	23.42
<b>32</b>	2 - 18 UNS	56.36	80.00	65.88	20.07	29.36
<b>36</b>	2-1/4 - 16 UN	62.71	80.00	69.06	20.07	31.75

All dimensions are in mm.  
Specifications & Dimensions subject to change.



**TBS62 & 63 SERIES**

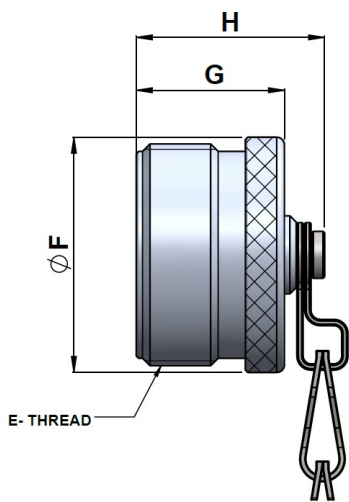

62 - PLUG COVER

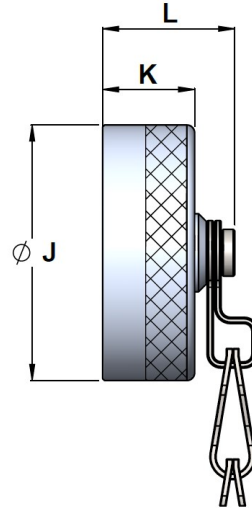

63 - RECEPTACLE COVER

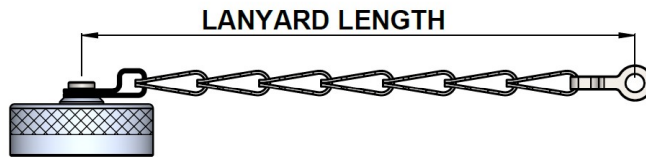

**ORDERING INFORMATION**

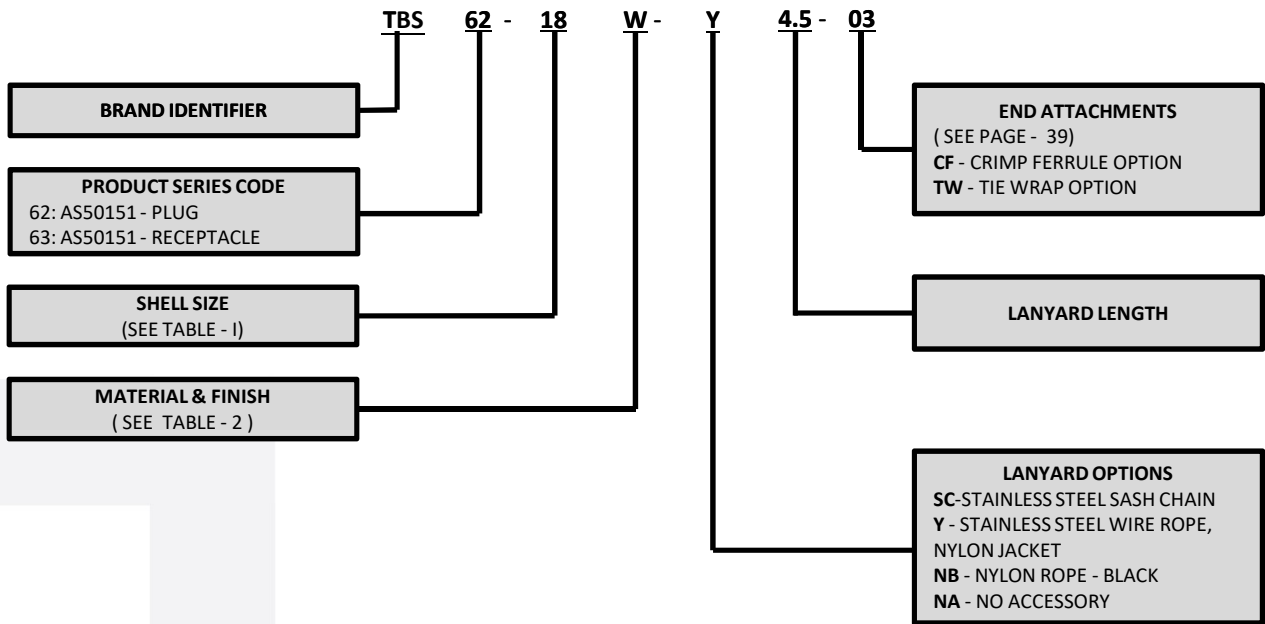

For customization contact [info@solotek.com.tr](mailto:info@solotek.com.tr)





TABLE - 1 SHELL SIZE DIMENSIONS

SHELL SIZE	E Thread	F Max	G Max	H Max	J Max	K Max	L Max	LANYARD LENGTH
10	5/8 - 24	17.40	16.70	24.61	20.70	11.80	19.05	101.60(4.00)
12	3/4 - 20	20.60	21.40	29.36	25.40	11.80	19.05	114.30(4.50)
14	7/8 - 20	23.80	21.40	29.36	28.60	11.80	19.05	114.30(4.50)
16	1 - 20	27.00	21.40	29.36	30.20	11.80	19.05	114.30(4.50)
18	1-1/8 - 18	30.10	21.40	29.36	34.10	11.80	19.05	114.30(4.50)
20	1-1/4 - 18	33.30	21.40	29.36	37.30	11.80	19.05	127.00(5.00)
22	1-3/8 - 18	36.50	21.40	29.36	40.50	11.80	19.05	127.00(5.00)
24	1-1/2 - 18	39.70	21.40	29.36	43.70	11.80	19.05	139.70(5.50)
28	1-3/4 - 18	46.00	21.40	29.36	50.00	13.50	20.62	196.85(7.75)
32	2 - 18	52.40	21.40	29.36	56.40	13.50	20.62	196.85(7.75)
36	2-1/4 - 16	58.70	21.40	29.36	62.70	13.50	20.62	196.85(7.75)

MATERIAL AND FINISH (TABLE 2)

CODE	DESCRIPTION
W	Olive Drab Cadmium
A	Black Anodized
N	Electroless Nickel
Z	Black Zinc Nickel
VO	Zinc Cobalt

EYELET

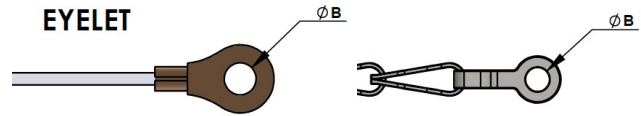

EYELET OPTION

DASH NO	ØB (mm)
00	NO EYELET
05	4.24

STRAIGHT RING

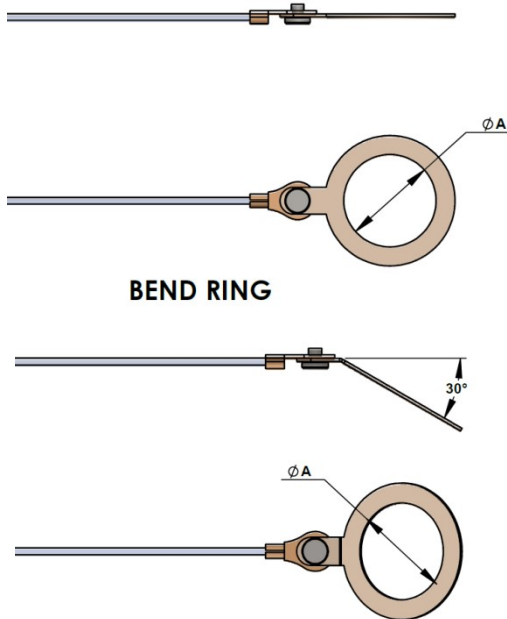

BEND RING

STRAIGHT RING		BEND RING	
DASH NO	ØA ±0.40 (mm)	DASH NO	ØA ±0.40 (mm)
150	15.0	150B	15.0
184	18.4	184B	18.4
232	23.2	232B	23.2
265	26.5	265B	26.5
303	30.3	303B	30.3
326	32.6	326B	32.6
365	36.5	365B	36.5
393	39.3	393B	39.3
429	42.9	429B	42.9
450	45.0	450B	45.0

All dimensions are in mm.

Specifications & Dimensions subject to change.



# OUR FACILITIES

**MARKETING & SALES**



**ENGINEERING & NPD**



**MACHINE SHOP**



**PLATING SHOP**



**ASSEMBLY**



**QUALITY**



**STORES**





Turbo India(TI), built on the foundations of a 25 plus year interconnect components manufacturing legacy of Turbo India, is where you can find a complete solution for your interconnect needs. We strive for “CUSTOMER DELIGHT” through strict adherence to Customer and Product requirements and by maintaining an open-door for customizations.

For enquiries, the customer may either propose a suitable part number, based on the ordering information provided, or the TI Sales & Engineering Teams can assist in choosing the best possible configuration, based on applications, from the standard solutions available or propose a custom solution with part numbers and lead times, at the earliest.

For supply of standard solutions referred to in this catalog, an order may be placed after generating the required part numbers from the ordering information page.

For any orders or enquiries you may mail us on [info@solotek.com.tr](mailto:info@solotek.com.tr)





Supporting the  
Global Military and Aerospace Industry

Scan to Reach  
Website



📍 No. 114, PC Industrial Estate, Bangalore-560079, Karnataka, India.

☎ +91 80234 83447 ✉ sales@turboindia.co.in 🌐 turboindia.co.in.